

# TANNER® SQUARE REBOUNDER SET UP

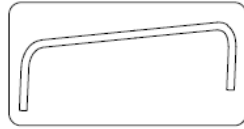

① X1

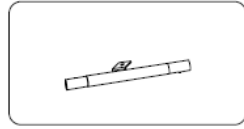

② X2

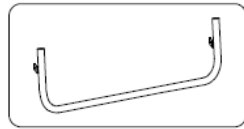

③ X1

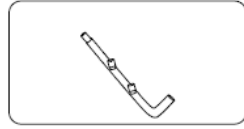

④ X1

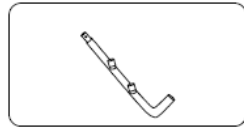

⑤ X1

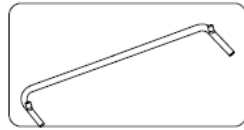

⑥ X1

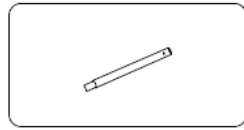

⑦ X2

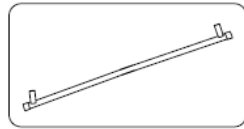

⑧ X1

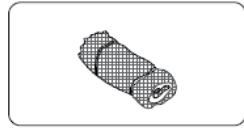

X1

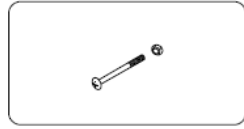

X4

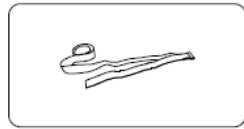

X1

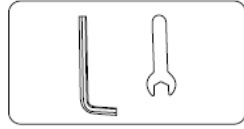

X1



X20

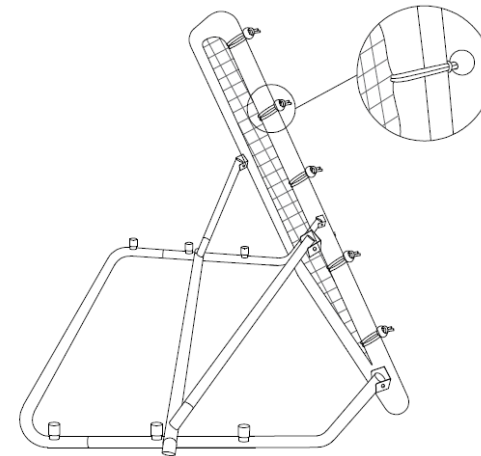
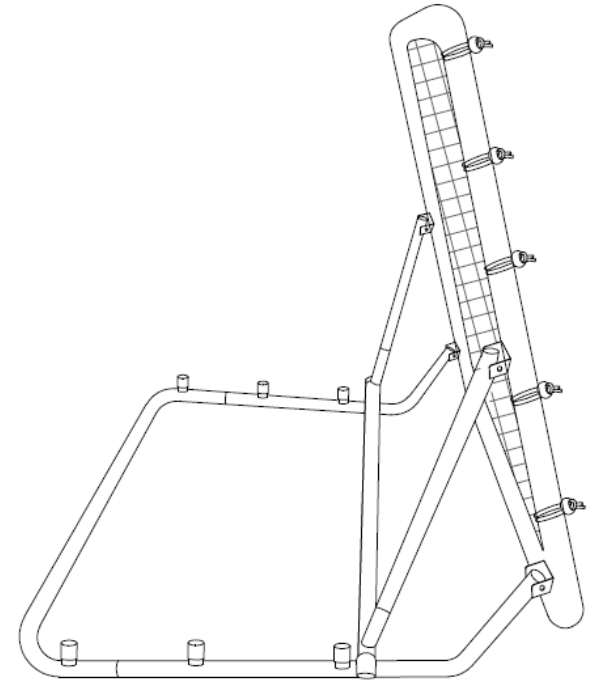
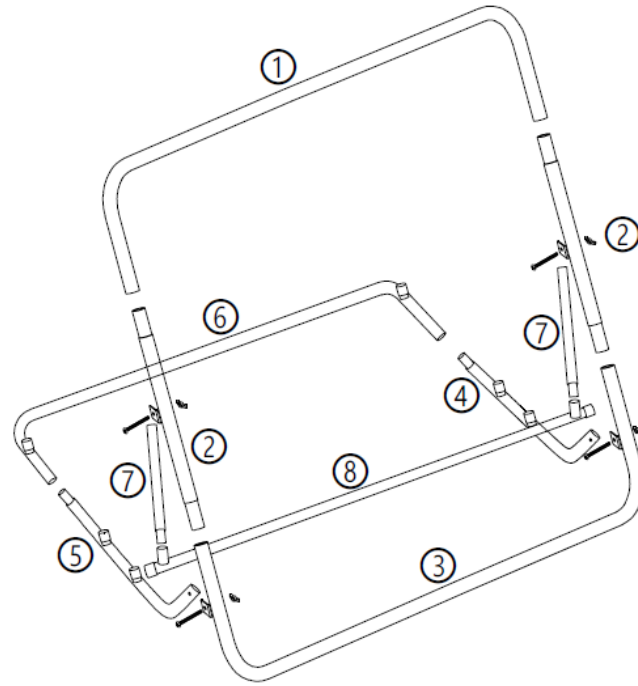

**1. Assemble Frame:** Follow the diagram to connect frame parts.

**2. Hand-Tighten Bolts:** Keep bolts loose for easy adjustment.

**3. Attach Net:** Evenly space elastic fasteners around the frame.

**4. Tighten Bolts:** Secure all bolts with Allen and standard wrenches.



**TANNER**

[Support@tannertees.com](mailto:Support@tannertees.com)

941-923-8584